

INFORMAZIONI TECNICHE

- Altezza (in mm) :** 34
Categoria : A soffiatti
Corsa : 15 mm
Diametro del collo interno : 8 mm
Diametro esterno : 63 mm
Diametro labbro : 63 mm
Forma : 1,5 soffiatti
Forza orizzontale : 139 N
Forza verticale : 69.5 N
Gamma : Ventosa
Massa : 35 g
Numero di soffiatti : 1,5 soffiatti
Serie : 1
Volume : 38.90 cm³

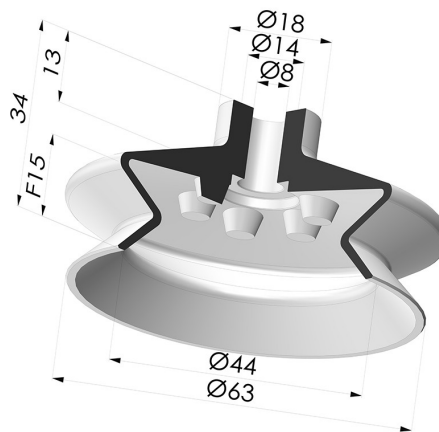

Varianti:



Riferimento variante:

1 63NI A

- Colore: Nero
- Durezza Shore: SH50
- Materiale: Nitrile



Riferimento variante:

1 63NR A

- Colore: Grigio
- Durezza Shore: SH50
- Materiale: Gomma naturale



Riferimento variante:

1 63SLT A

- Colore: Trasparente
- Certificato alimentare CE
- Durezza Shore: SH 60
- Materiale: Silicone



Riferimento variante:

1 63MNT A

- Colore: Bordeaux
- Durezza Shore: SH 60
- Materiale: Antialone





Riferimento variante:

1 63SLBLEU A

- Colore: Blu Certificato alimentare CE
- Durezza Shore: SH 60
- Materiale: Silicone

Guida ai materiali:









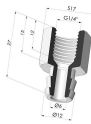
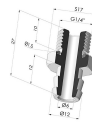
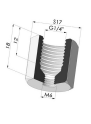

	Materiale	Codice	Resistenza temperatura (°C)	Flessibilità	Resistenza abrasione	Resistenza UV/Intemperie	Resistenza oli	Compatibilità alimentare	Test di migrazione
	Nitrile Nero	NI	-10/+80	✓	✓	✗	✓✓	✗	✗
	Gomma naturale Grigio	NR	-20/+70	✓✓✓	✓✓	✗✗	✗✗	✗	✗
	Silicone Trasparente Certificato alimentare CE	SLT	-60/+250	✓✓✓	✗	✓✓✓	✗	FDA ☞☞	✗

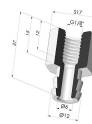
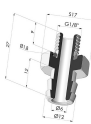
	Antialone Bordeaux	MNT	-20/+160	✓	✓	✓✓✓	✓✓✓	✗	✗
	Silicone Blu Certificato alimentare CE	SLBLEU	-60/+250	✓✓✓	✗	✓✓✓	✗	FDA ☞☞	A, B, D2

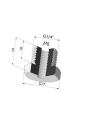
Le richieste di certificati FDA e/o CE devono essere effettuate OBBLIGATORIAMENTE al momento dell'ordine. Una richiesta successiva comporterà costi aggiuntivi. Per soddisfare le aspettative dei nostri clienti industriali, NOVACOM dispone della più ampia gamma di materiali elastomerici o termoplastici. Possiamo inoltre sviluppare nuovi materiali secondo un capitolato tecnico preciso, al fine di risolvere applicazioni specifiche per i nostri clienti.

 Eccellente |
  Buona |
  Media |
  Bassa |
  Non raccomandato
 *È possibile richiedere un certificato FDA e/o CE su diverse referenze al momento dell'ordine; contattateci.
 ** Certificazione per contatto alimentare: (CE) 1935/2004 - (FDA) 21 CFR 177.2600
 *** Certificazione per contatto alimentare: (CE) 10/2011 - (FDA) 21 CFR

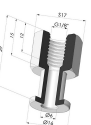
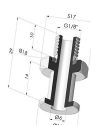
Prodotti correlati:

 <p>Inserto a resca Femmina G1/4" Riferimento prodotto: D</p>	 <p>Inserto a resca Maschio G1/4" Riferimento prodotto: E</p>	 <p>Adattatore - Femmina G1/4" - Femmina M6 Riferimento prodotto: F14F6</p>	 <p>Adattatore - Femmina G1/8" - Femmina M6 Riferimento prodotto: F18F6</p>	 <p>Inserto a resca Femmina G1/8" Riferimento prodotto: H</p>
 <p>Inserto a resca Maschio G1/8" Riferimento prodotto: I</p>	 <p>Inserto Rivettato Femmina G1/4" Riferimento prodotto: L</p>	 <p>Inserto Rivettato Maschio G1/4" Riferimento prodotto: M</p>	 <p>Adattatore - Maschio G1/8" - Femmina M6 Riferimento prodotto: M14F6</p>	 <p>Adattatore - Maschio G1/8" - Femmina M6 Riferimento prodotto: M18F6</p>
 <p>Vite M5 - ØTesta 14MM - L 20.5MM Riferimento prodotto: M5</p>	 <p>Vite M6 - ØTesta 14MM - L 20.5MM Riferimento prodotto: M6</p>	 <p>Inserto Rivettato Femmina G1/8" Riferimento prodotto: R</p>	 <p>Inserto Rivettato Maschio G1/8" Riferimento prodotto: S</p>	 <p>Vite M8 - ØTesta 14MM - L 20MM Riferimento prodotto: M8T14L20.5</p>