

**TECHNICAL INFORMATION**

<b>Arrow :</b>	1 mm
<b>Category :</b>	Plates
<b>Contact lip diameter :</b>	22
<b>Height (in mm) :</b>	17
<b>Horizontal force :</b>	16 N
<b>inner barrel diameter :</b>	M5
<b>Number of bellows :</b>	0.5 Bellows
<b>Range :</b>	Suction cup
<b>Series :</b>	90
<b>Shape :</b>	Plate
<b>Vertical force :</b>	8 N

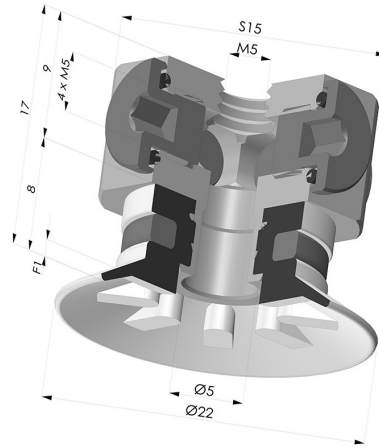

**Variants:**



Variant reference:  
**90 20SL FM5BD**

- Color: Red food-grade CE certification
  - Matter: Silicone
  - Shore Hardness: SH60



Variant reference:  
**90 20SLT FM5BD**

- Color: Translucent
  - CE food certified
  - Matter: Silicone
- Shore Hardness: SH60



Variant reference:  
**90 20NI FM5BD**

- Color: Black
  - Matter: Nitrile
- Shore Hardness: SH50

**Related products:**

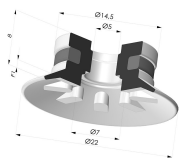

**Flat Suction Cup Series 90, Ø 20 mm**

Product reference: 90 20-- A